

VEGA

Design: Giorgio Cattelan



Descripción Producto

Escritorio en acero inox brillo o revestido en nogal Canaletto (NC) o roble ahumado (RB) con interior barnizado graphite mate (OP69). Accesorios disponibles: d ctilo en el mismo acabado del escritorio (debe ser apoyado por la cajonera), cajonera sobre ruedas a dos cajones con estructura pintada graphite (OP69) y frontales en cuero seg n muestrario. Pad en cuero seg n muestrario. Peque as irregularidades de reflexi n en el escritorio acero se deben a la producci n manual.

VEGA

Design: Giorgio Cattelan

Medidas

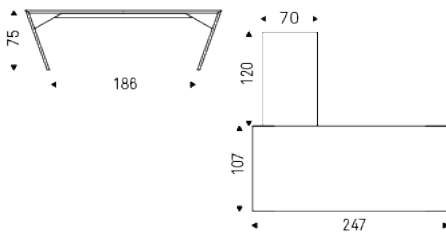
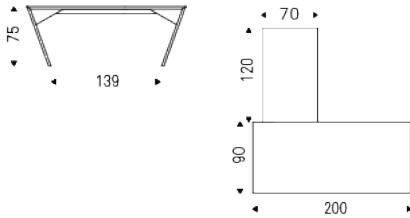

VEGA

Design: Giorgio Cattelan

Acabados: estructura

madera



NC nogal
canaletto



OP69 graphite
mate

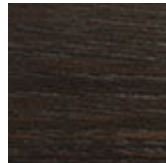

RB roble
ahumado

metal



acero inox brillo

Acabados: pad

cuero



71 BIANCO

97 PANNA

47 OYSTER

48 LINO

65 ICE

49 CENERE

51 CASTORO



83 ARGILLA

52 SMOKE

53 ARDESIA

59 CANNA DI
FUCILE

73 NERO

50 TORTORA

42 FANGO



60 BRUNO

88 TABACCO

91 TESTA DI
MORO

89 ROSSO CORSA

76 AMARANTO

70 BORDEAUX

82 COGNAC



84 BRONZO

80 OTTANIO

74 CAPRI

Acabados: cajones

cuero



71 BIANCO

97 PANNA

47 OYSTER

48 LINO

65 ICE

49 CENERE

51 CASTORO



83 ARGILLA

52 SMOKE

53 ARDESIA

59 CANNA DI
FUCILE

73 NERO

50 TORTORA

42 FANGO



60 BRUNO

88 TABACCO

91 TESTA DI
MORO

89 ROSSO CORSA

76 AMARANTO

70 BORDEAUX

82 COGNAC



84 BRONZO

80 OTTANIO

74 CAPRI

INFORMACIÓN GENERAL Y MANTENIMIENTO

LOS CUEROS son materiales naturales. Una homogeneidad no perfecta del diseño, arrugas y signos debe considerarse una característica, que certifique la naturalidad del cuero. Las pieles experimentan una ligera alteración del color con el tiempo, ya sea por exposición a fuentes directas de luz o calor. Tenga cuidado con cinturones, tachuelas, botones u otros objetos metálicos afilados que puedan cicatrizar el revestimiento.

MANTENIMIENTO: es una buena práctica eliminar a menudo el polvo que se asienta, obstruye los poros y evita la transpirabilidad natural. Utilice sólo un paño suave y seco. Evite el uso de cepillos que puedan dañar la superficie. La eliminación de manchas es extremadamente difícil como en el caso de las manchas de grasa, tinta y alcohol. Los buenos resultados se logran interviniendo rápidamente con agua jabonosa o leche desmaquillante, enjuagar y secar inmediatamente con un paño suave. El alcohol, la acetona, la trielina, los detergentes o los abrasivos deben evitarse absolutamente.

Cattelan Italia **LEATHER** esta producido con pieles bovinas seleccionadas, está curtido y teñido con productos que no contienen sustancias perjudiciales para la salud humana en cumplimiento total de la normativa vigente.

MANTENIMIENTO: ver las indicaciones proporcionadas para la piel.

SIMILPELLE, SYNTHETIC NUBUCK y MICRO NUBUCK son un tejido ecológico especial completamente similar al cuero aunque no hecho con material animal. Tiene excelentes cualidades técnicas, higiénicas e inofensivas desde un punto de vista toxicológico, no produce polvo ni alergias en contacto con la piel. Por último, el alto rendimiento elástico es una excelente garantía de durabilidad.

MANTENIMIENTO: no requiere cuidados especiales. En caso de manchas pasan con un paño húmedo. Utilice productos neutros específicos. No utilice cepillos, sustancias grasas, gasolina o acetona que dañen la superficie.

TELAS con respecto a la composición fibrosa, características técnicas e instrucciones de mantenimiento, consulte la información en el sitio web de cattelaItalia.com sección "Acabados".

PINTURA, LACADO Y PINTURA EN RELIEVE Las principales características son la resistencia a la luz y la corrosión. La pintura en relieve también hace que la superficie sea mucho más resistente a los arañazos, gracias a su película granulada.

MANTENIMIENTO: Para una limpieza normal utilice un paño suave ligeramente húmedo. No utilice detergentes abrasivos, disolventes, amoníaco o acetona. Para la eliminación de manchas utilizar una solución de jabón neutro y agua teniendo el cuidado de secar las superficies húmedas inmediatamente.

Los **WOODS** utilizados en los productos CATTELAN ITALIA se seleccionan entre los mejores disponibles en el mercado, provienen de plantaciones renovables y se procesan con tecnologías capaces de garantizar durabilidad y resistencia al estrés. Apreciar la madera significa entender que es un material natural y, como tal, siempre sigue evolucionando en sus cualidades y cromatidad. Pequeñas variaciones de tono, presencia de "nudos vivientes", vetas y arterias dan testimonio de la autenticidad y singularidad de cada producto individual.

MANTENIMIENTO: ver las indicaciones proporcionadas para material.

LAMINATE es un material altamente resistente a los impactos, agua, vapor, calor, manchas, luz y agentes químicos.

MANTENIMIENTO: Para la eliminación de manchas más resistentes utilice un paño húmedo con agua y detergentes líquidos.

MÁRMOL y PIEDRAS NATURALES, están protegidos por una capa repelente de hidro-aceite que protege las superficies. El pulido de plomo da brillo a la superficie de las losas y resistencia a la luz y el clima, lo que garantiza una excelente durabilidad.

MANTENIMIENTO: para una correcta limpieza y protección de las superficies de piedra natural o mármol utilizar sólo productos específicos siguiendo los criterios de uso relacionados indicados. No utilice detergentes agresivos que puedan dañar la superficie y afecten al tratamiento repelente de hidro-aceite. Por lo tanto, se recomienda limpiar, proteger y pulir sólo con productos específicos para piedra natural o mármol con frecuencia cíclica para una durabilidad perfecta.

CERÁMICA las losas se obtienen con una tecnología innovadora, gracias a un proceso de molienda húmeda de productos naturales, como arcillas de cantera, rocas de granito y pigmentos cerámicos y la posterior compactación y cocción.

MANTENIMIENTO: Las tapas de gres deben limpiarse con una esponja mojada con un detergente líquido normal, se deben evitar los productos muy abrasivos; no utilice limpiadores de vapor en absoluto, si que recomendamos productos de gel anti-cal. Es importante eliminar la suciedad inmediatamente, recién detectada, porque después de algún tiempo, las diferentes sustancias pueden penetrar en los poros del material; sin embargo, en el caso de la presencia de halos o manchas es suficiente se puede frotar con una mezcla de bicarbonato de sodio y agua, dejar actuar y luego limpiar con una esponja doméstica húmeda normal.

ARCILLA es un revestimiento multicapa de bajo espesor, cada capa se aplica manualmente con una espátula y se deja secar de forma natural. El proceso se completa con una última capa protectora para preservar la superficie y la opacidad natural del material. El proceso de producción de la arcilla y sus mezclas surge de la mezcla de tierras, esto permite obtener colores y acabados naturales. La presencia de imperfecciones debe considerarse como un elemento distintivo del material trabajado a mano.

MANTENIMIENTO: proteger la superficie de la caída de objetos contundentes, evitar el contacto directo con llamas u objetos muy calientes. Para la limpieza diaria utilice un paño suave humedecido con agua y detergentes neutros suaves multiusos, seque la superficie con un paño suave o papel absorbente. Elimina restos de comida, líquidos o grasas en pocas horas para evitar manchas permanentes.

VIDRIO, CRISTALARTE y ESPEJOS, todos los vidrios, tanto templados como no, tienen características de seguridad que corresponden a los requisitos exigidos.

GLASS, CRYSTALART y MIRRORS, todos los cristales sean templados y no, tienen características de seguridad que cumplen con los requisitos requeridos.

MANTENIMIENTO: Evite el uso de materiales abrasivos que puedan arruinar permanentemente la superficie. Para los espejos, se recomienda utilizar sólo un paño suave empapado en alcohol.

POLIURETANO a través de la tecnología de molde frío, es posible hacer que la espuma de poliuretano tome cualquier tipo de forma. Gracias a la memoria con la que está equipado el material, una vez finalizada la fase de moldeo, la forma obtenida es inmutable. A través de la dosis correcta de componentes, la suavidad se puede lograr adecuado para cada necesidad de comodidad.

MANTENIMIENTO: Para una limpieza normal utilice un paño suave ligeramente húmedo. No utilice detergentes abrasivos, amoníaco, disolventes. Para la eliminación de manchas utilizar una solución de jabón neutro y agua teniendo el cuidado de secar las superficies húmedas inmediatamente.

INSTRUCCIONES DE MONTAJE

Si se van a ensamblar componentes, siga cuidadosamente las instrucciones incluidas dentro del embalaje. Los tornillos, pernos y otros componentes de fijación deben apretarse preferiblemente a mano. No utilice herramientas eléctricas. Si tiene alguna dificultad, póngase en contacto con su distribuidor de confianza para obtener ayuda. No utilice el producto para usos distintos del relacionado con la categoría a la que pertenece.

DISPOSICIÓN

Cuando se complete el uso, no deseche los muebles en el medio ambiente. Póngase en contacto con empresas especializadas para su recuperación y/o eliminación.

GARANTÍA

Este Certificado de Garantía se aplica a todos los productos CATTELAN ITALIA, y sólo es válido en los casos en que el bien adquirido tenga defectos objetivos de conformidad o no respete las descripciones y aspectos cualitativos y de rendimiento expresados por el vendedor, fabricante o agente. La garantía se aplica al producto hasta 2 años después de la entrega. La garantía está destinada a ser proporcionada en el punto de venta y sólo es válida en presencia de la fecha y sello del minorista, nota adjunta o recibo de impuestos. La garantía es aplicable únicamente por defectos en la conformidad del producto preexistente con la entrega del mismo y excluye cualquier otro tipo de defecto de origen posterior, si no se reconoce objetivamente. Además, se excluyen de la aplicabilidad del Certificado de Garantía los siguientes aspectos: daños en el transporte, daños o rotura de productos como resultado de una manipulación y/o almacenamiento incorrectos en el almacén de la tienda o distribuidor, anomalías y deterioros del uso, arañazos y abrasiones, manchas, exposición al agua, luz solar directa, calor excesivo o frío, vandalismo, uso anormal y/o incorrecto del producto, tratamiento incorrecto de materiales. Los productos fabricados a partir de materiales suministrados por el cliente y la manipulación o los intentos de reparación de los bienes sin autorización por escrito de CATTELAN ITALIA también están excluidos de la garantía. La información que se muestra aquí se basa en los últimos datos publicados en la lista de precios en línea. La empresa se reserva el derecho de realizar cambios en los modelos sin previo aviso.

La información que se muestra aquí se basa en los últimos datos publicados en la lista de precios en línea. La empresa se reserva el derecho de realizar cambios en los modelos sin previo aviso.