

# AIRPORT

Design: Giorgio Cattelan



## Description du produit

Bibliothèque à éléments avec fixation au mur ou au plafond. Montants et supports en acier gaufré titane (GFM11), bronze (GFM18), graphite (GFM69) blanc (GFM71) ou noir (GFM73). Etagères et conteneurs en bois gaufré graphite (GF69), blanc (GF71), en noyer Canaletto (NC), rouvre brûlé (RB), Brushed Bronze ou Brushed Grey.

## AIRPORT

Design: Giorgio Cattelan

### Dimensions

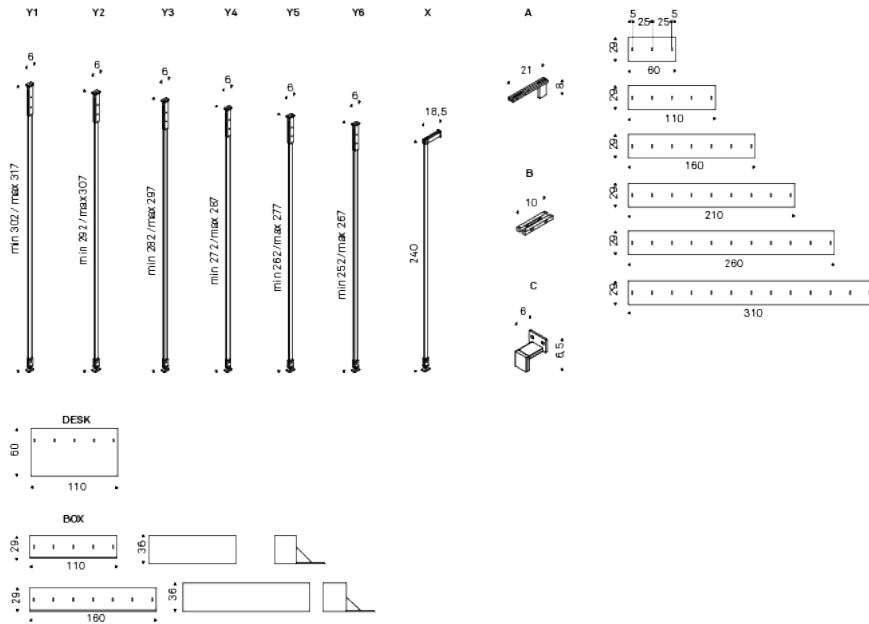

# AIRPORT

Design: Giorgio Cattelan

## Finitions: structure

### *metals*

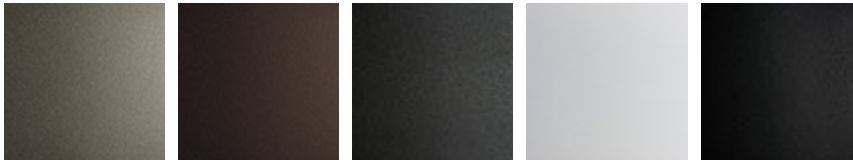

GFM11 gaufré  
titane

GFM18 gaufré  
bronze

GFM69 gaufré  
graphite

GFM71 gaufré  
blanc

GFM73 gaufré  
noir

## Finitions: conteneur

### *bois*

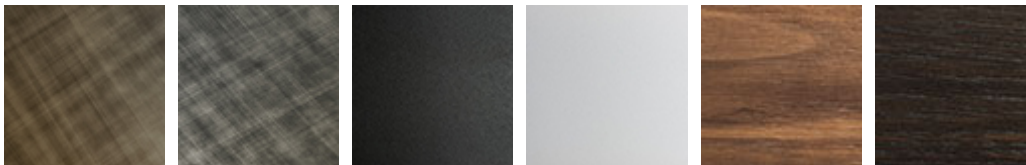

brushed bronze

brushed grey

GF69 gaufré  
graphite

GF71 gaufré  
blanc

NC noyer  
canaletto

RB rouvre brûlé

## Finitions: étagères

### *bois*

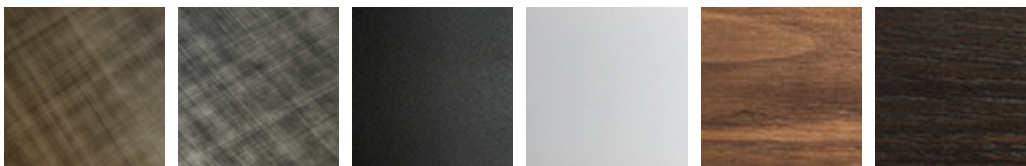

brushed bronze

brushed grey

GF69 gaufré  
graphite

GF71 gaufré  
blanc

NC noyer  
canaletto

RB rouvre brûlé

## CONDITIONS GENERALES ET ENTRETIEN

Les **CUIRS SOUPLES** sont des matériaux naturels. Une homogénéité imparfaite du dessin, des rides et des signes doit être considérée comme une caractéristique qui certifie la naturalité du cuir. Dans le temps, la couleur des peaux subit un léger changement, du soit à l'exposition de la lumière directe soit à des sources de chaleur. Attention aux ceintures, clous, boutons et à tout autre objet pointus en métal qui pourraient marquer le revêtement.

**ENTRETIEN** : il est préférable prendre l'habitude de dépoussiérer souvent la peau car la poussière obstrue les pores et empêche la transpiration naturelle. Utilisez uniquement un chiffon doux et sec. Évitez d'utiliser des brosses qui peuvent griffer la surface. L'élimination des taches est extrêmement difficile comme dans le cas des taches de graisse, d'encre et d'alcool. De bons résultats sont obtenus en intervenant rapidement avec de l'eau savonneuse ou du lait démaquillant, rincer et essuyer immédiatement avec un chiffon doux. Éviter l'utilisation d'alcool, acétone, détergent au trichloréthylène ou abrasifs.

**CATTELAN ITALIA CUIR/ Le CUIR** de Cattelan Italia, produit avec des peaux de bovin sélectionnées, est tanné et teint avec des produits qui ne contiennent pas de substances nocives pour la santé humaine, en respectant les réglementations en vigueur.

**ENTRETIEN** : Voir les indications données pour les cuirs souples.

**SIMILICUIR, NUBUCK SYNTHETIQUE et NUBUCK MICRQ** il s'agit d'un tissu écologique spécial complètement similaire au cuir bien qu'il ne soit pas fabriqué avec des matières animales. Il possède d'excellentes qualités techniques, hygiéniques et inoffensives d'un point de vue toxicologique, il ne produit pas de poussières ni d'allergies au contact de la peau. Enfin, le rendement élastique élevé est une excellente garantie de durabilité.

**ENTRETIEN** : il ne nécessite pas de soins particuliers. En cas de taches, essuyer avec un chiffon humide. Utilisez des produits neutres spécifiques. N'utilisez pas de brosses, de corps gras, d'essence ou d'acétone qui endommagent la surface.

**TISSUS**, pour ce qui concerne de la composition fibreuse, les caractéristiques techniques et les consignes d'entretien, se référer aux informations du site [cattelanitalia.com](http://cattelanitalia.com) dans la section "finitions".

**PEINTURE, LAQUAGE ET PEINTURE EN RELIEF** Les principales caractéristiques sont la résistance à la lumière et à la corrosion. De plus, la peinture en relief rend la surface plus résistante aux rayures, grâce à son film granuleux.

**ENTRETIEN** : pour un nettoyage normal, utilisez un chiffon doux légèrement humide. N'utilisez pas de nettoyeurs abrasifs, de solvants, d'ammoniac ou d'acétone. Pour éliminer les taches, utilisez une solution d'eau et de savon neutre en ayant soin de bien sécher immédiatement les surfaces humides.

Les **BOIS** utilisés dans les produits CATTELAN ITALIA sont sélectionnés parmi les meilleurs disponibles sur le marché, proviennent de plantations renouvelables et sont traités avec technologies capables de garantir la durabilité et la résistance aux sollicitations. Apprécier le bois, cela signifie de comprendre qu'il s'agit d'un matériau naturel et, en tant que tel, il continue toujours d'évoluer dans sa qualité et sa chromaticité. De petites variations de ton, la présence de "nœuds vivants", de veines et de flammes témoigne l'authenticité et l'unicité de chaque produit individuel.

**ENTRETIEN** : Voir les instructions données pour la peinture.

**LAMINE** est un matériau extrêmement résistant aux chocs, à l'eau, à la vapeur, à la chaleur, aux taches, à la lumière et aux produits chimiques.

**ENTRETIEN** : Pour éliminer des taches plus tenaces, utilisez un chiffon humide avec de l'eau et des détergents liquides.

**MARBRE et PIERRES NATURELLES** sont protégés par une couche hydro-oléofuge qui protège les surfaces. Le polissage au plomb donne aux dalles un éclat et une résistance à la lumière, et une protection aux agents atmosphériques, ce qui garantit une excellente durabilité.

**ENTRETIEN** : pour un nettoyage et une protection correcte des surfaces en pierre naturelle ou en granit, utilisez des produits spécifiques selon les critères d'utilisation relatifs indiqués. N'utilisez pas de détergents agressifs qui peuvent matifier la surface et endommager le traitement eau-huile. Il est donc conseillé de nettoyer, protéger et polir uniquement avec des produits spécifiques pour pierre naturelle ou granit régulièrement pour une parfaite durabilité.

**CÉRAMIQUE**, les dalles sont obtenues avec une technologie innovante, grâce à un processus de broyage humide de produits naturels, tels que des argiles de carrière, des roches granitiques et des pigments céramiques, ainsi qu'à la compacité et à la cuisson ultérieures.

**ENTRETIEN** : Les plateaux en Grès doivent être nettoyés avec une éponge humide et un détergent liquide normal, éviter les produits très abrasifs ; n'utilisez pas de nettoyeurs à vapeur, toutefois sont recommandés des produits en gel anticalcaire. Il est important d'enlever le plus vite possible les taches, car après un certain temps, les différentes substances peuvent pénétrer dans les pores du matériau ; s'il y a des auréoles ou des taches, il suffit de frotter avec un mélange de bicarbonate et d'eau, laisser agir puis nettoyer avec une éponge ménagère normale humide.

**L'ARGILE** est un revêtement multicouche de faible épaisseur, dont chacune est appliquée manuellement avec une spatule et puis séchée naturellement. L'usage est terminé par une dernière couche de protection afin de préserver la surface et l'opacité naturelle du matériau. Le processus de production de l'argile et de ses pâtes découle du mélange des terres, ce qui permet des couleurs et des finitions naturelles. La présence d'imperfections doit être considérée comme un élément distinctif du matériau fabriqué à la main.

**ENTRETIEN** : protéger la surface des chutes d'objets contondants, éviter le contact direct avec des flammes ou des objets très chauds. Pour le nettoyage quotidien, utilisez un chiffon doux humide et de détergents neutres polyvalents doux, séchez la surface avec des chiffons doux ou serviettes en papier absorbant. Enlevez les résidus alimentaires, les liquides ou les graisses rapidement pour éviter les taches permanentes.

**VERRE, CRYSTALART et MIROIRS**, tous les verres, tant les verres trempés que les verres non trempés, ont de caractéristiques de sécurité correspondant aux besoins requis.

**ENTRETIEN** : évitez d'utiliser des matériaux abrasifs qui peuvent endommager la surface de façon permanente. Pour les miroirs, il est recommandé d'utiliser uniquement un chiffon doux humide d'alcool.

**POLYURÉTHANE** Grâce à la technologie du moule à froid, il est possible façonner la mousse de polyuréthane dans la forme souhaitée. Grâce à la mémoire dont est doté le matériau, une fois la phase de moulage terminée, la forme obtenue est inaltérable. Grâce au bon dosage des composants, il est possible d'obtenir une souplesse adaptée à toutes les exigences de confort.

**ENTRETIEN** : pour un nettoyage normal, utilisez un chiffon doux légèrement humide. N'utilisez pas de nettoyeurs abrasifs, d'ammoniac, de solvants. Pour éliminer les taches, utilisez une solution d'eau et de savon neutre en ayant soin de bien sécher immédiatement les surfaces humides.

## INSTRUCTIONS D'ASSEMBLAGE

Si on doit assembler des composants, suivez attentivement les instructions fournies à l'intérieur de l'emballage. Il est recommandé de serrer vis, boulons et autres éléments de fixation à la main. N'utilisez pas d'outils électriques. En cas de difficulté, contactez votre concessionnaire fiable pour toute assistance. N'utilisez pas le produit pour des usages autres que ceux liés à la catégorie à laquelle il appartient.

## ELIMINATION DU PRODUIT

Ne jetez pas le meuble dans l'environnement. Confiez-le à des sociétés spécialisées pour son recouvrement et/ou son élimination.

## GARANTIE

Ce certificat/attestation de garantie s'applique à tous les produits CATTELAN ITALIA et n'est valable que dans les cas où le produit acheté présente des défauts objectifs de conformité ou ne respecte pas les descriptions et les aspects qualitatifs et fonctionnelles exprimée par le vendeur, le fabricant ou l'agent. La garantie s'applique au produit jusqu'à 2 ans à la date de livraison. La garantie est fournie sur le lieu de vente et n'est valable qu'en présence de la date et du timbre du revendeur, du bordereau de livraison ou du ticket de caisse.

La Garantie s'applique uniquement aux défauts de conformité du produit préexistants à la livraison de celui-ci et exclut tout autre type de défauts d'origine postérieure, s'ils ne sont pas objectivement reconnus. Sont également exclus de l'applicabilité du Certificat de Garantie les aspects suivants : dommages de transport, dommages ou bris des produits résultant d'une manipulation et/ou d'un stockage incorrect dans l'entrepôt du point de vente ou du distributeur, anomalies et détérioration d'utilisation, rayures et abrasions, taches, exposition à l'eau, lumière directe du soleil, chaleur ou froid excessif, vandalisme, utilisation anormale et / ou incorrecte du produit, soin incorrect des matériaux. Sont également exclus de la garantie les produits fabriqués avec des matériaux fournis par le client et les altérations ou tentatives de réparation de la marchandise sans l'autorisation écrite de CATTELAN ITALIA.

*Les informations fournies sont basées sur les dernières données publiées sur la liste de prix en ligne. L'Enterprise se réserve le droit d'apporter des modifications aux modèles sans préavis.*